

SUPERMARKET G3 ALUMINIUM SINGLE COMPONENTS SW 41

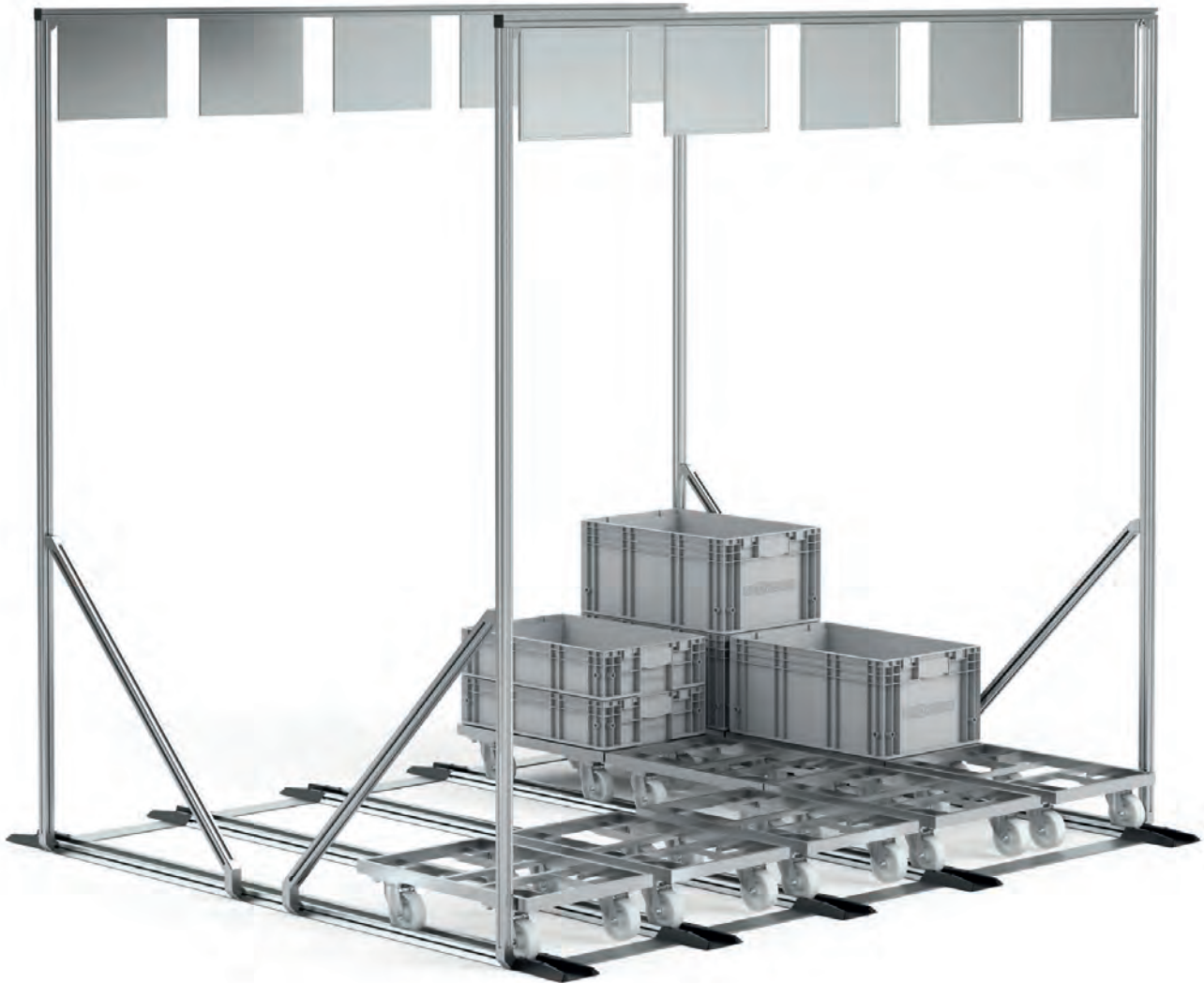

One-sided wheel guidance – single line system

The rail width (SW) 41mm is suitable for trolleys with a **maximum wheel width of 40mm.**



SUPERMARKET G3 ALUMINIUM SINGLE COMPONENTS SW 41

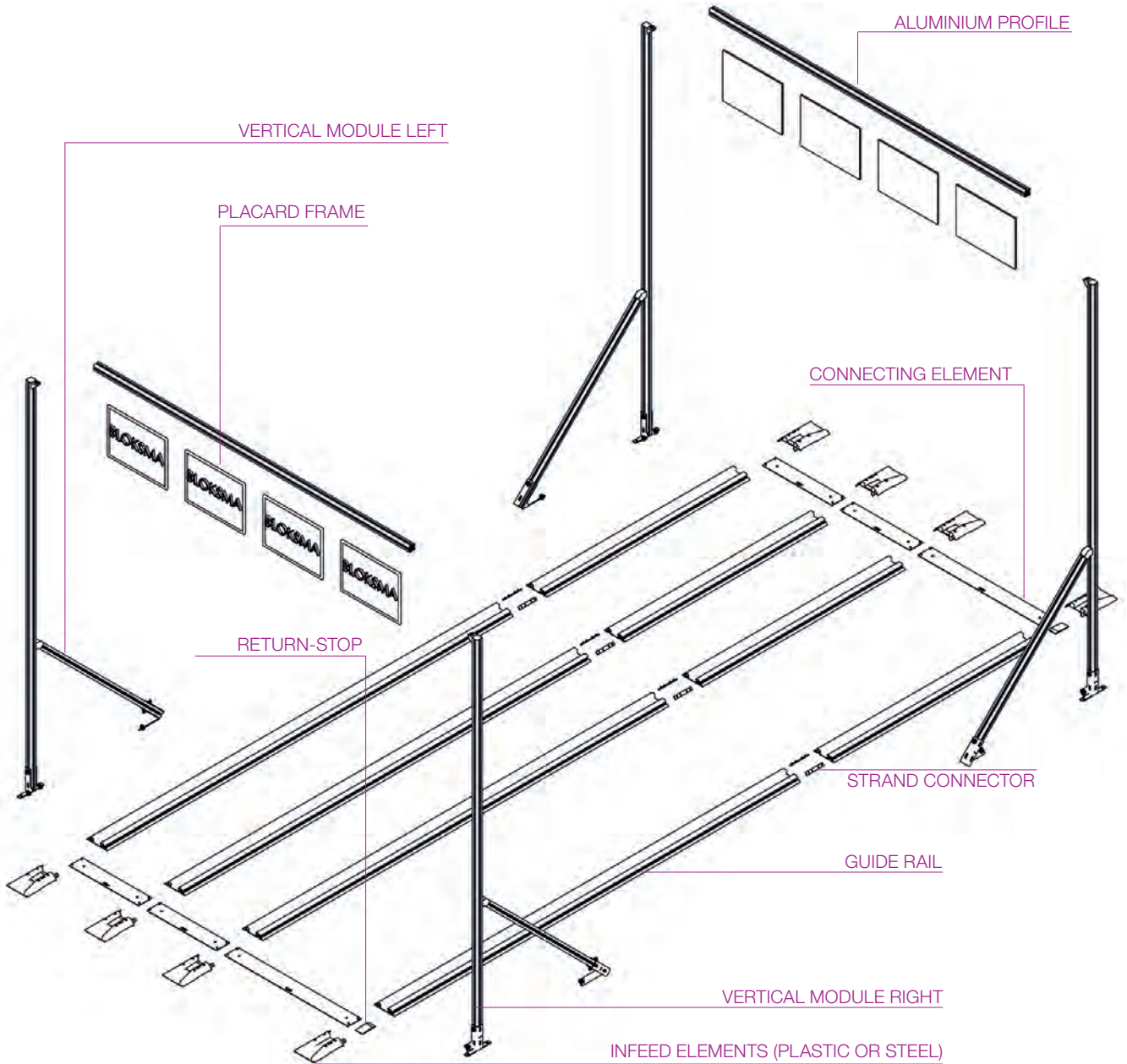

3

LABELING POSSIBILITIES

H



HANGING VIA ALUMINIUM PROFILE

K



HANGING FROM CEILING

D



ROTATABLE VIA ALUMINIUM PROFILE

P



STANDING

B



STANDING VIA ALUMINIUM PROFILE

SUPERMARKET G3 ALUMINIUM SINGLE COMPONENTS SW 41



Infeed elements and guidance rails

The supermarket organises the material provision according to the FIFO principle. Due to the modular structure each supermarket is adjusted to your individual requirements resp. spatial conditions. The track width /SW) 41 mm is suitable for trolleys with a **maximum wheel width of 40 mm**.

Construct your own supermarket with our single components or use the checklist in the catalogue for guidance. You can also use our online inquiry form or contact us directly with questions or concerns. We are happy to help you with the design.

3

INFEED ELEMENTS SW 41mm

Item no.	description	paint
138124-9005	Infeed element (plastic)	black RAL 9005
138124-1021	Infeed element (plastic)	yellow RAL 1021
138124-2009	Infeed element (plastic)	orange RAL 2009
138124-5002	Infeed element (plastic)	ultramarine RAL 5002
138124-6016	Infeed element (plastic)	turquoise green RAL 6016
138124-3001	Infeed element (plastic)	red RAL 3001
further colors on request		
210667	Infeed element (steel)	electrogalvanized (very robust)

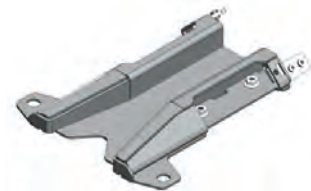
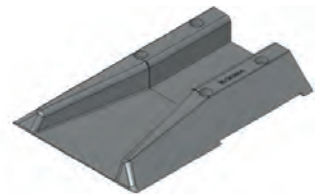

GUIDANCE RAILS SW 41mm

Example: **138318-0800A** anodised aluminium rail with a length of 800mm

Item no.	length	processing
138318-xxxxx	— — — —	—
Please enter the desired length of the profile here		A = galvanized E = yellow (alike RAL 1021)
132917-xxxx	cover profile for guidance rails 8er groove (max. 2,000mm)	Plastic

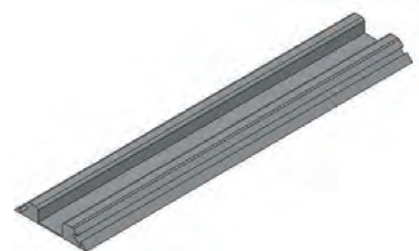
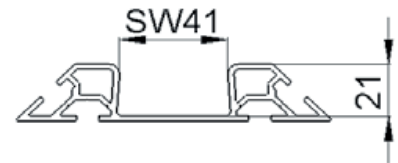

Other models / dimensions on request
Subject to technical changes



SUPERMARKET G3 ALUMINIUM SINGLE COMPONENTS SW 41

Connection elements and stoppers

The rail width (SW) 41mm is suitable for trolleys with a **maximum wheel width of 40 mm.**

CONNECTING ELEMENT

Item no.	description	designed to	model
211451-xxxx	BG-connector with variable rail length		
201500-0396	BG-connector lengthwise interposed	trolley 600x400mm model BOF	
201500-0714	BG-connector lengthwise interposed	trolley 600x400mm model BOF	
201500-0596	BG-connector crosswise interposed	trolley 600x400mm model BOF	
201500-0996	BG-connector crosswise interposed	trolley 600x400mm model BOF	
201500-0796	BG-connector crosswise interposed	trolley 800x600mm model BOF	
201500-1514	BG-connector crosswise interposed	trolley 800x600mm model BOF	
201500-0460	BG-connector lengthwise interposed	trolley 630x430mm model BOZ	
201500-0785	BG-connector lengthwise interposed	trolley 630x430mm model BOZ	
142327	BG-shackles		
138759	connecting element check rail		

lengthwise

crosswise

fowel flap

connecting element for guide rail

STOPPER

Item no.	description	designed to	model
141427-0040A	non-return device 10mm	check rail SW 41	
144417-0040A	non-return device 6mm	check rail SW 41	
142073	end stop - rail	check rail SW 41	
139621	brush brake - retrofit	aluminium check rail	
202219-LI	ZB-stopper left	aluminium check rail	
202219-RE	ZB-stopper right	aluminium check rail	

non return device

end stop

brush brake

Stopper

SUPERMARKET G3 ALUMINIUM SINGLE COMPONENTS SW 41



Labeling and vertical modules

The rail width (SW) 41mm is suitable for trolleys with a **maximum wheel width of 40mm.**

VERTICAL MODULE

Example: **202216-L2100** BG-vertical module left, height 2,100mm

Item no.	length/height	description	dimension A	model
202216-L_ _ _ _	_ _ _ _ _	BG vertical module left for trolley 600x400 mm model BOF	measure A 41mm	
202216-R_ _ _ _	_ _ _ _ _	BG vertical module right for trolley 600x400 mm model BOF	measure A 41mm	
202247-L_ _ _ _	_ _ _ _ _	BG vertical module left for trolley 630x430 mm model BOZ	measure A 52,5mm	
202247-R_ _ _ _	_ _ _ _ _	BG vertical module right for trolley 630x430 mm model BOZ	measure A 52,5mm	

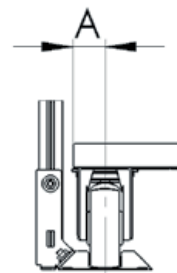

3

Please enter the desired height of the aluminium profile here.

Please contact us if the measurement A of your trolley is not listed, so that we can design and calculate the accurate vertical module for your supermarket.

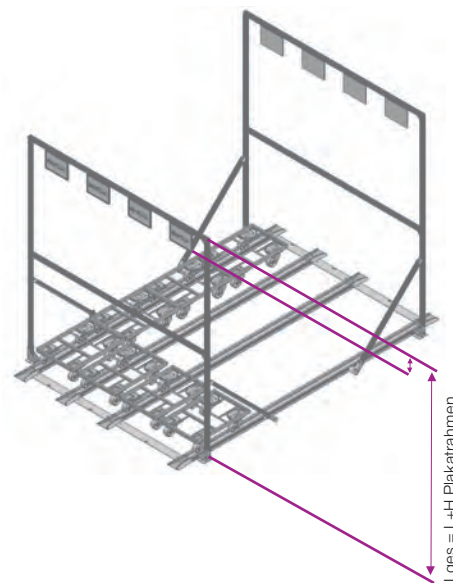
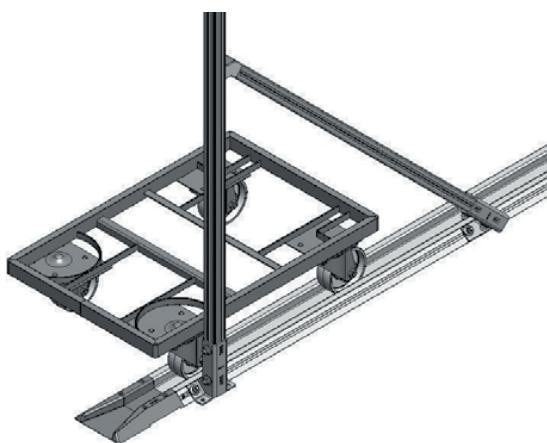

Please take into account the height of the placard frame when calculating the option 'hanging connection'. The total height. **Lges** = desired passage height + height of the placard frame



SUPERMARKET G3 ALUMINIUM SINGLE COMPONENTS SW 41

Connection elements and stoppers

The rail width (SW) 41mm is suitable for trolleys with a **maximum wheel width of 40mm.**

PROFILE HOLDER

Item no.	description	designed to	model
202237-V	BG-profile holder in front	trolley BOF 600x400mm	
202237-L	BG-profile holder left	trolley BOF 600x400mm	
202237-R	BG-profile holder right	trolley BOF 600x400mm	
202236-V	BG-profile holder in front	trolley BOZ 630x430mm	
202236-L	BG-profile holder left	trolley BOZ 630x430mm	
202236-R	BG-profile holder right	trolley BOZ 630x430mm	
209702-V	BG-profile holder movable	diverse trolleys	
202217	BG-profile holder round pipe	trolley BOF 600x400mm	
202979-L	stabiliser left	trolley BOF 600x400mm	
202979-R	stabiliser right	trolley BOF 600x400mm	

3

ALUMINIUM PROFILE

Item no.	length	processing	description	model
132401	_____	A	aluminium profile 30x30mm labeling from ceiling or with vertical modules possible	
132404	_____	A	aluminium profile Ø 28mm labeling from ceiling	
142419	_____	A	aluminium profile round Ecoshape labeling from ceiling with vertical modules possible	

please insert preferred rail height A = anodized