

MATERIALFLOW AND FACTORY EQUIPMENT SUPERMARKET



CUSTOMIZED
OR STANDARD

BLOKSMA

SPECIALIZED PROFESSIONALIZED PERFECTED



Dirk Bloksma, Dipl.-Ing. (FH)
Qualified expert for
Lean Management

„MATERIAL FLOW OPTIMIZATION IS OUR STRENGTH. FOR MORE THAN 40 YEARS, WE HAVE BEEN ADVISING COMPANIES OPERATING WORLDWIDE AND DEVELOPING SUITABLE CONCEPTS TOGETHER IN ORDER TO INCREASE PRODUCTIVITY.“

HISTORIE



- 1920** BLOKSMA founded in the Netherlands.
- 1949** Establishment of BLOKSMA GmbH for the manufacture and repair of water coolers for automobiles in Germany by Hendrik Marinus Bloksma.
- 1958** Herman A. Bloksma joins the company at the age of 16 years.
- 1972** Development of first products for material flow optimization by Herman A. Bloksma.
- 1978** Patenting of the first container tipping device by Herman A. Bloksma.
- 1992** Dirk Bloksma joins the company.
- 2004** Dirk Bloksma takes over the management of BLOKSMA-Engineering GmbH. He and his team consistently realized their vision of a complete service for production processes.



TABLE OF CONTENTS

ADVANTAGES OF BLOKSMA

Page 4-5

INDUSTRIES

Page 6

ORDER INSTEAD OF CHAOS

Page 7

KANBAN AND FIFO-SYSTEM

Page 8-9

CUSTOMIZED SUPERMARKET

Page 10-13

SUPERMARKET GENERATOR ONLINE

Page 14-15

STRUCTURE AND COMPONENTS

Page 16-17

OUR CHAMPION

Page 18

INDIVIDUAL COMPONENTS

Page 19-23

ACCESSORIES

Page 24-25

APPLICATIONS

Page 26-27

ADVANTAGES OF BLOKSMA

1

**EVERY-
THING FROM
ONE SOURCE**

1. SALES

2. ENGINEERING

3. MANUFACTURING



EVERYTHING FROM **ONE SOURCE**

Our different departments work closely together. We have short communication channels and can quickly respond to individual designs and change requests.

2



INDIVIDUAL AND CUSTOMIZED **CONSTRUCTION**

Our designs are unique and tailored to the customer and their needs.

3



COMPREHENSIVE OFFERING
THROUGH
**STRONG PARTNER-
SHIPS**

We work closely with our partners, ensuring we are always at the cutting edge of technology.

Years of global **EXPERIENCE**

Our sales network extends far beyond our national borders. The first supermarket was developed and constructed by BLOKSMA. We draw on many years of experience.

4

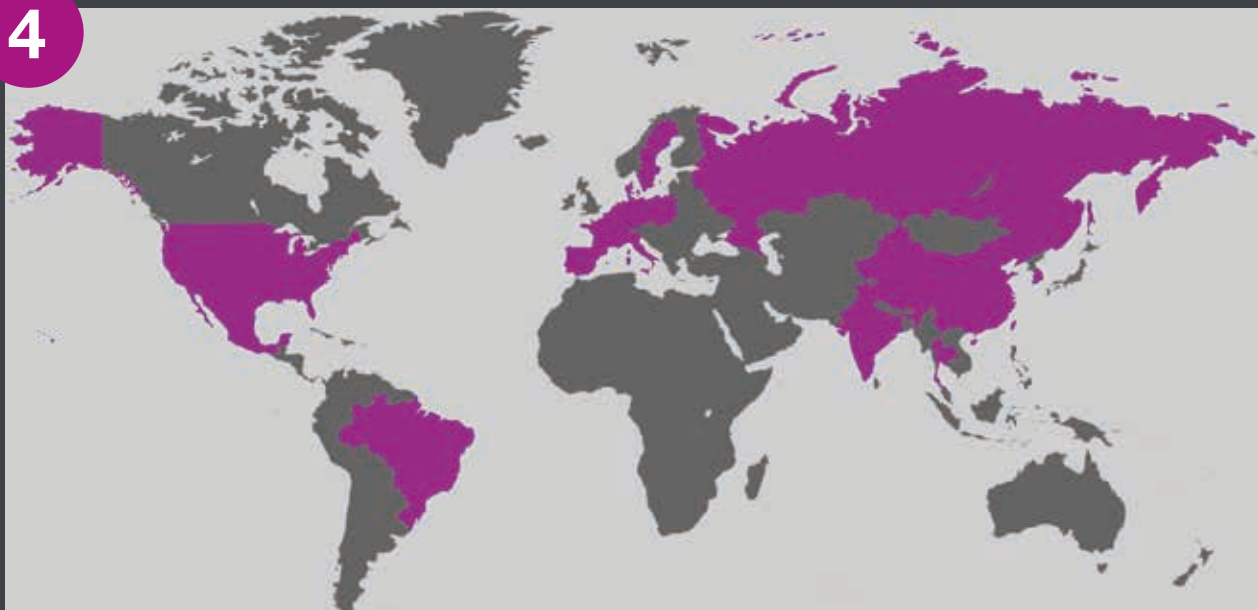

INDUSTRIES



AUTOMATION



AUTOMOTIVE / COMPONENTS
MACHINING



LOGISTICS



TOOLS



SANITARY / FITTINGS



ELECTRONIC DEVICES



ENGINES



LIGHTING / LIGHTING
TECHNOLOGY



AEROSPACE



PHARMA /
MEDICAL TECHNOLOGY



AGRICULTURE / FARMING



FOOD / FOODSTUFFS

ORDER INSTEAD OF CHAOS

Supermarkets ensure structured provision of goods and components. As a **premium manufacturer, BLOKSMA** focuses on aluminum supermarkets that meet all requirements.

BY FULFILLING INDIVIDUAL CUSTOMER REQUIREMENTS, MANY DIFFERENT MODELS HAVE ALREADY BEEN BUILT.

The material required for production and assembly is neatly provided in the supermarket according to the First-in-first-out (FIFO) and Kanban system.

In the smallest space, always ready for pick-up, and consistently reliable in exact quantity.

BLOKSMA's supermarkets meet a variety of requirements. Primarily, they are designed for the provision of goods, which are stored on trolleys and intended for rapid consumption.

All supermarkets are modular and tailored precisely to your needs. Benefit from our experience.

ORDERLINESS WITH A BLOKSMA SUPERMARKET



Supermarkets serve as material buffers between workstations. To prevent chaos, rails are laid out. These accommodate trolleys and make them ready for pick-up. This ensures orderly replenishment and timely delivery of goods.

CHAOS WITHOUT A SUPERMARKET



If trolleys are left without guidance on a storage space due to the absence of a supermarket, there is a risk of losing oversight. Unsecured trolleys can create tripping hazards, leading to serious accidents. Operational safety is not guaranteed.

SUPERMARKET KANBAN AND FIFO-SYSTEM

Needs-based Provision of All Materials

- Precisely tailored to your needs
- Complete systems and individual components
- Various components to choose from
- Standard components in stock
- Short delivery times
- Custom lengths to the exact centimeter
- Modular design for high flexibility
- On-site: analysis, consultation and assembly

Can be automated
with AMR (automated mobile robots)

Infinitely expandable
through modular design

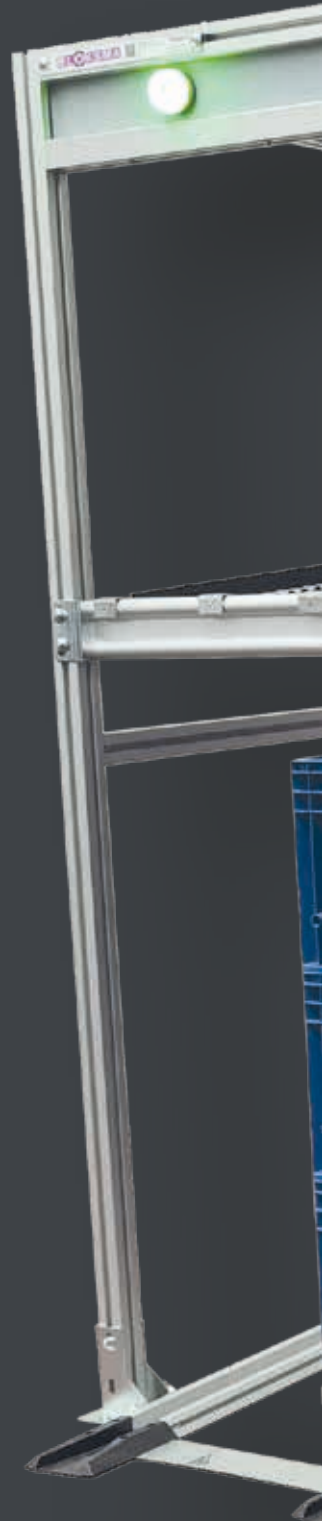

Supply
Standard or Custom-made



Housing or top-structure
with roller conveyor

BLOKSMA Online
Supermarket-Generator

CREATION OF A CUSTOM-SPECIFIC SUPERMARKET

1



NEEDS ANALYSIS

Through a personal consultation, our trained staff can assess your situation and create a tailored offer. Additionally, there is a checklist available on our website for completion and download. With our new Online Supermarket Generator, you can configure your own supermarket.

2



OFFER

We can promptly provide you with an offer that is precisely tailored to your needs.

3

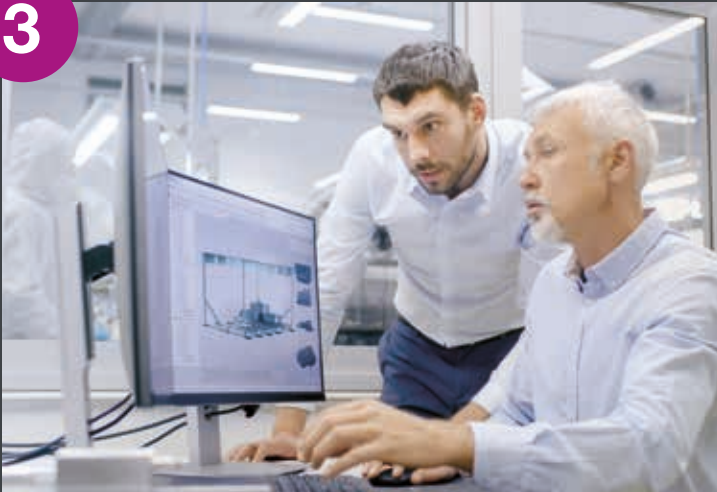

CONSTRUCTION

Before commencement of manufacturing, you will receive a construction drawing from us for review and approval.

4



APPROVAL

Changes and corrections can still be made before approval.

CREATION OF A CUSTOM-SPECIFIC SUPERMARKET

5



MANUFACTURING + COMMISSIONING

After approval, the supermarket will be produced for you. Typically, each supermarket is individually packaged, ensuring accurate identification of which components belong to each supermarket.

6



SHIPPING

Our BLOKSMA professionals also come into play here. We ensure optimal packaging, and guide rails can be stacked to avoid oversized freight transport, which is costly and unsustainable.

7



ON-SITE ASSEMBLY

Customers receive top-notch service here as well. You have the choice: either assemble the supermarket yourself, or we will gladly come to you to assemble it for you. If you choose to assemble the supermarket yourself, we will provide you with appropriate drawings, a parts list, and a video tutorial.

A futuristic robot head and torso are shown in a blue-tinted digital environment. The robot has a white, smooth face with large, expressive eyes and a metallic neck. The background features various data visualizations, including line graphs, bar charts, and a grid pattern, all rendered in a light blue color. The overall aesthetic is clean and high-tech.

**BLOKSMA:
FUTURE
IS NOW**

SUPERMARKET GENERATOR ONLINE

**BLOKSMA:
LET'S GO!**

SUPERMARKET GENERATOR ONLINE

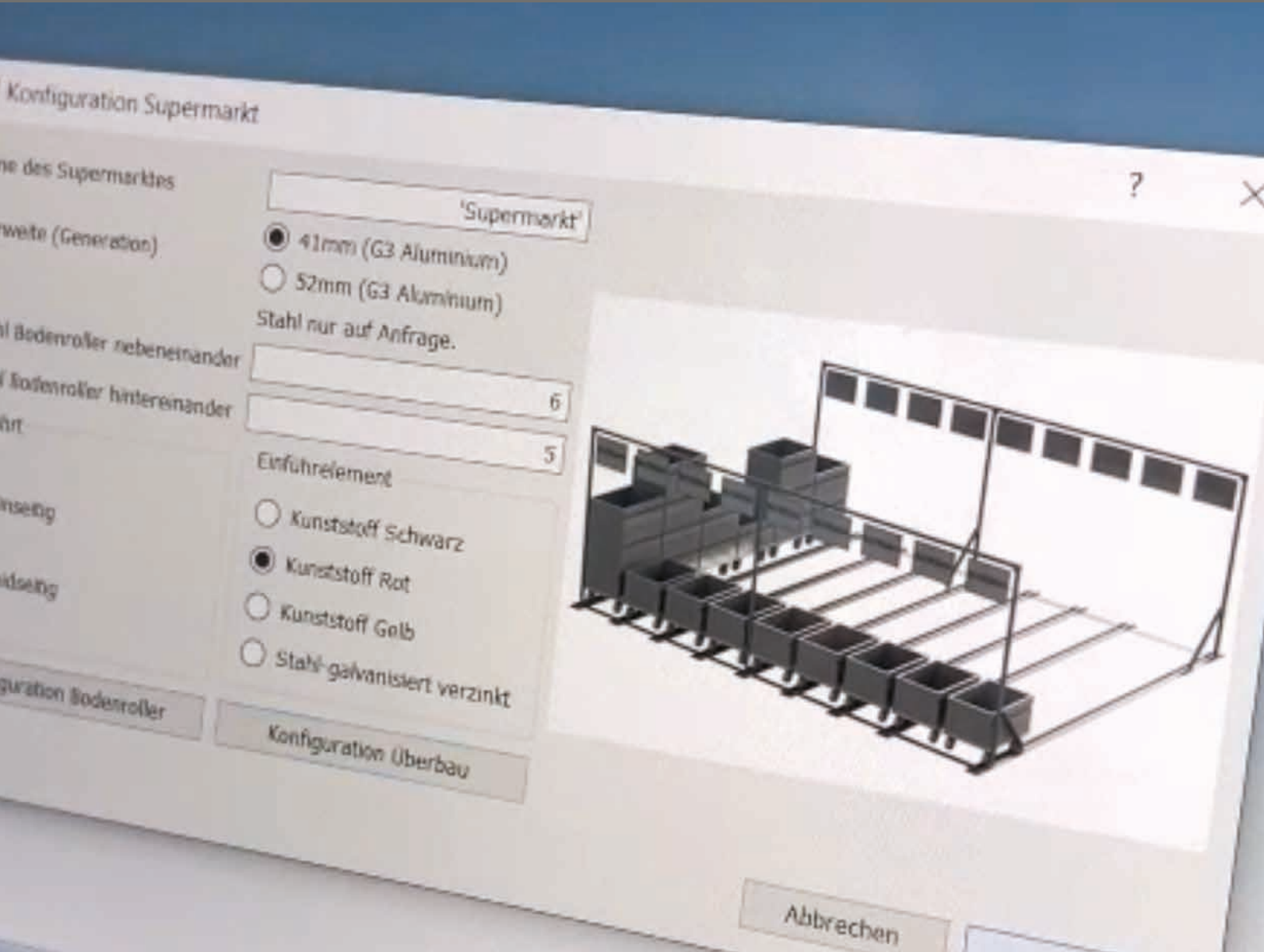

GUIDE TO GETTING STARTED IMMEDIATELY

With the Online Supermarket Generator, you can easily and quickly generate your own personalized supermarket. The generator is structured so that you first enter the general parameters of your supermarket, then you input the specifications of your existing or required trolleys. If needed, you can configure a Top-structure for your supermarket.

Within a few days, you will receive a personalized offer from BLOKSMA. Shortly after, your personal supermarket will be ready for assembly.

SUPERMARKET STRUCTURE AND COMPONENTS

- 1 Aluminum profile
- 2 Placard frame
- 3 Vertical module left
- 4 Vertical module right
- 5 Strand connector
- 6 Guide rail
- 7 Connecting elements
- 8 Infeed element
- 9 Return stop

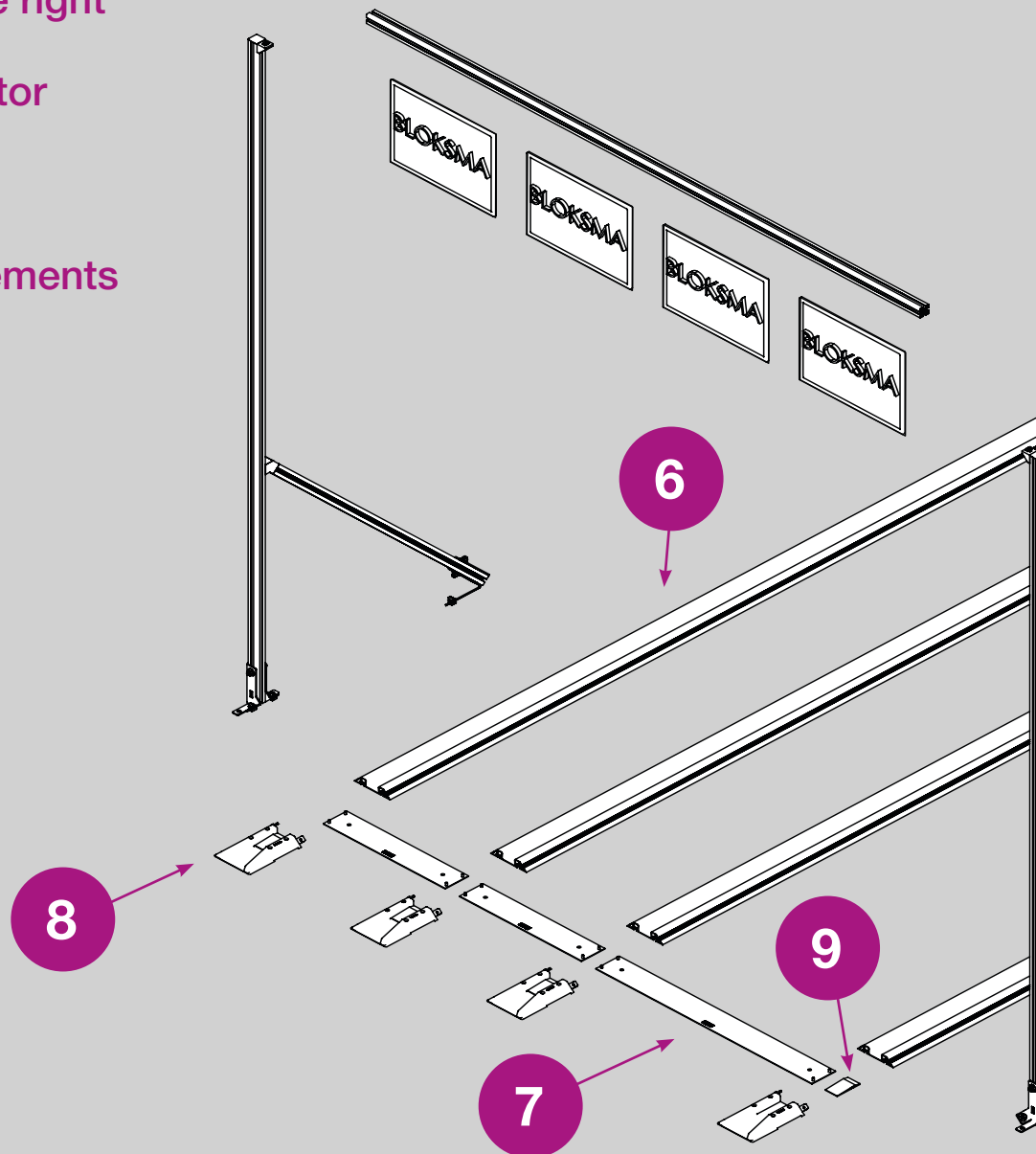

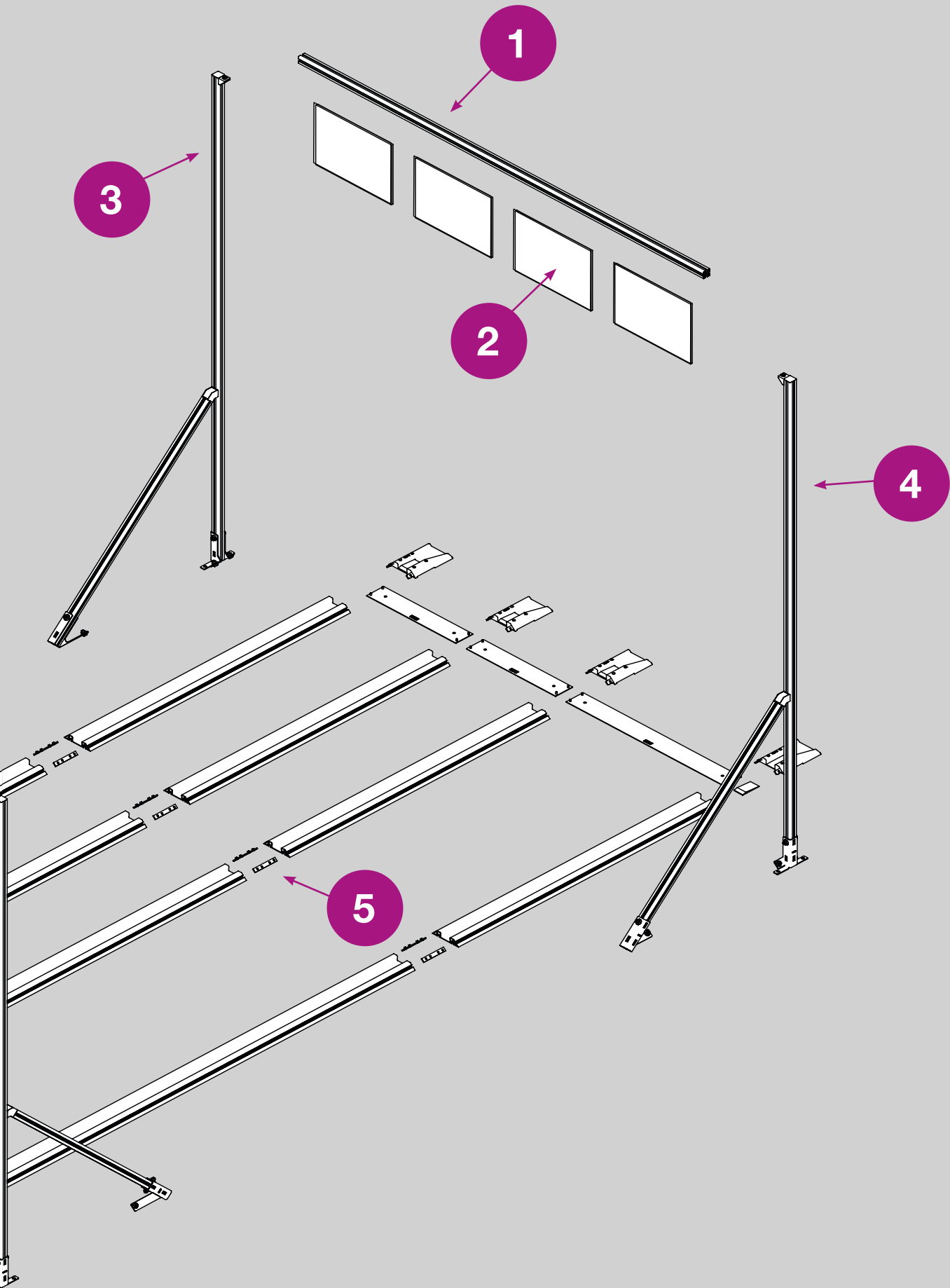



OUR CHAMPION ALUMINUM SUPERMARKET

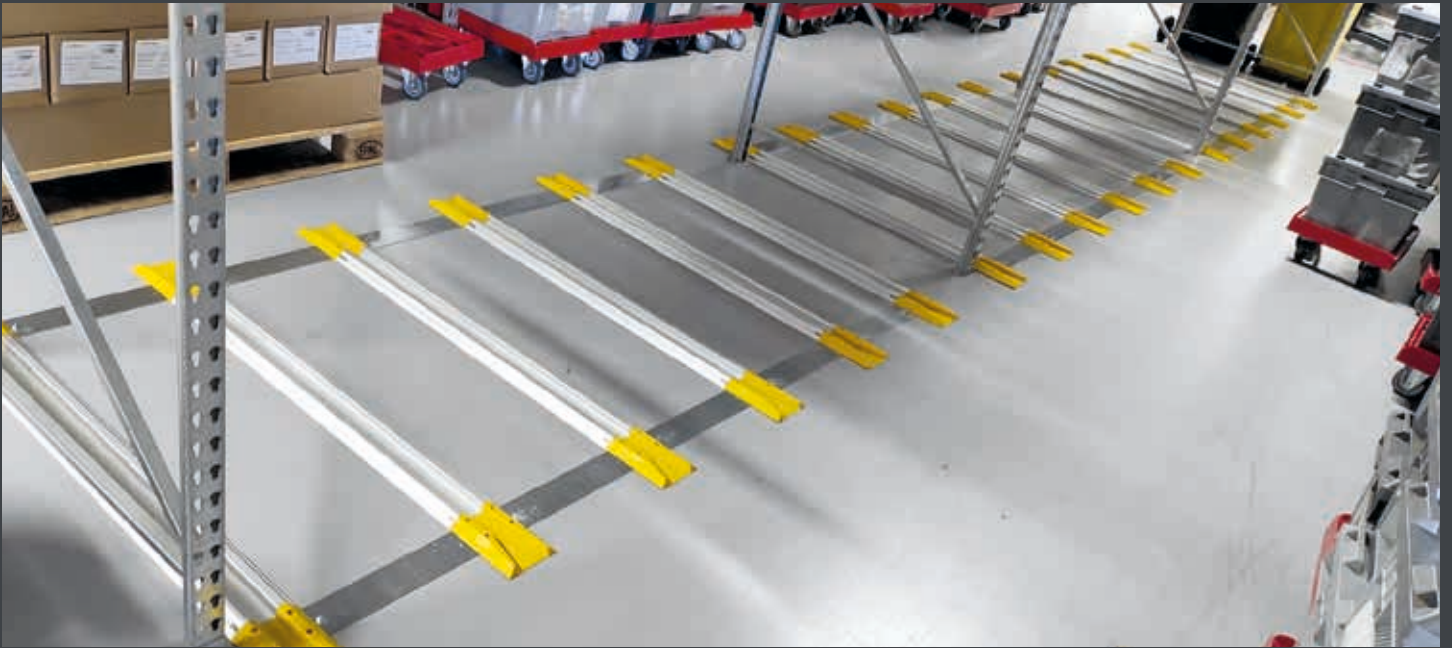

The aluminum supermarket is characterized by its lightweight and flexibility. Its modular construction allows for easy expansion or adaptation to changes at any time. Compared to steel, aluminum is cheaper to produce and has become equally stable and durable. Aluminum can be delivered in various colors. Upon request, BLOKSMA also offers the supermarket in steel or stainless steel.



PROFILE RAILS

Anodized aluminum is standard. Upon request, the aluminum can be powder-coated in color.

Profile:



* Sonderfarben auf
Anfrage möglich



INDIVIDUAL COMPONENTS

TRACK WIDTHS

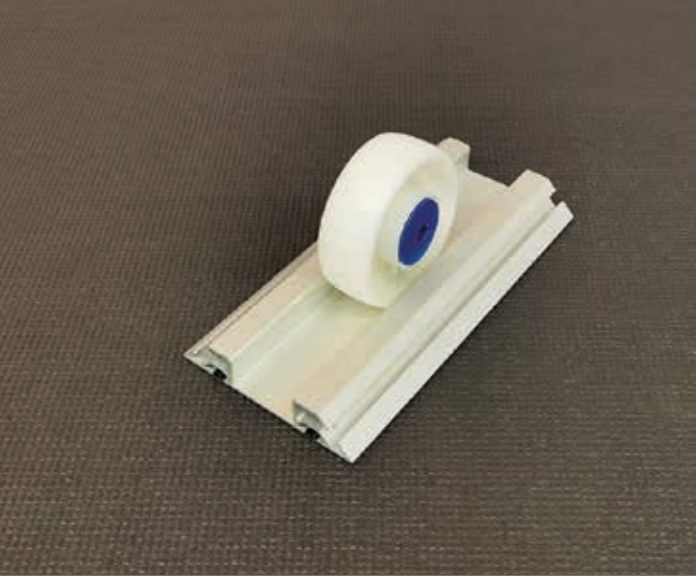

RAIL WIDTH SW 41

- Rail width 41 mm
- Custom lengths available
- Recommended for wheel widths up to 40 mm
- Material: one-piece aluminum
- Standard surface is anodized
- Available in color upon request (powder-coated)
- Continuous groove for attaching overhead labeling or a top-structure with conveyor belt on shelf or similar.

RAIL WIDTH SW 52

- Rail width 52 mm
- Custom lengths available
- Recommended for wheel widths 42 mm to 50 mm
- Material: one-piece aluminum
- Surface: Standard anodized, also available in color upon request (powder-coated)
- Continuous groove for attaching overhead labeling or a top-structure with conveyor belt on shelf or similar.

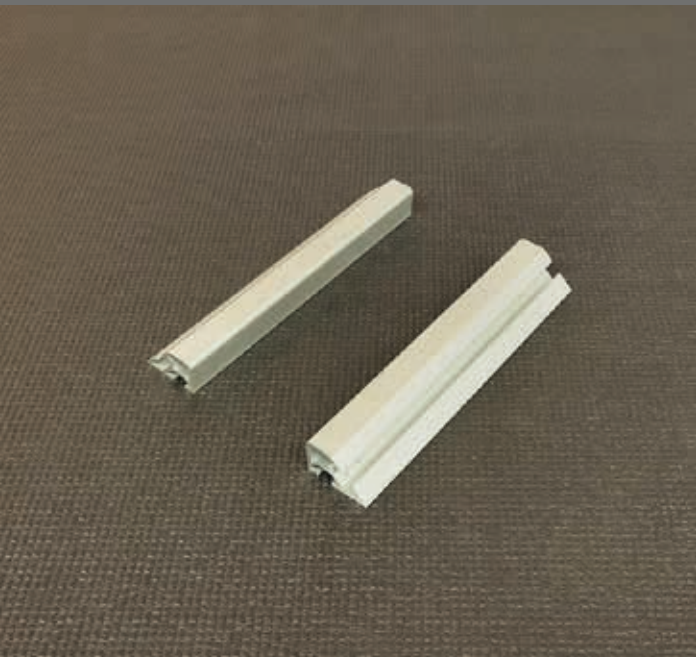
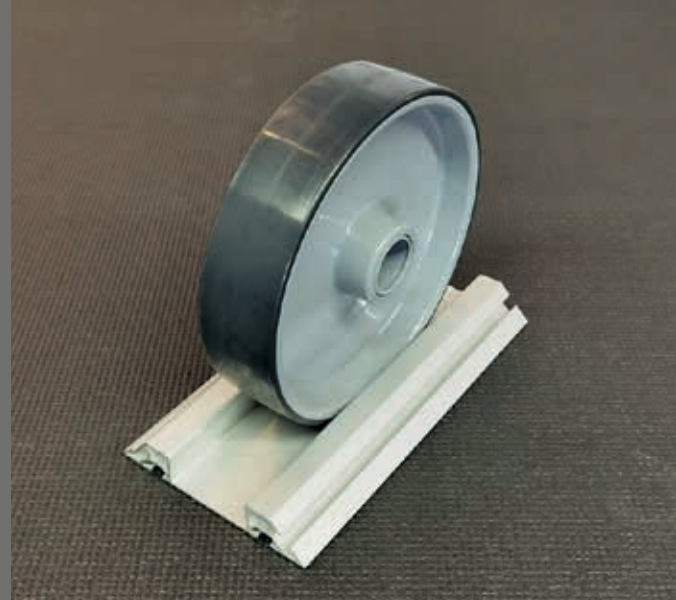

FLEXIBLE RAIL WIDTH ESD-CAPABLE (G7)

- Rail width: individual, suitable for large wheel widths
- Material: two-piece aluminum
- Custom lengths available
- ESD capability of the trolley is ensured
- Surface: Standard anodized
- Available in color upon request (powder-coated)
- Continuous groove for attaching overhead labeling or a top-structure with conveyor belt on shelf or similar

INDIVIDUAL COMPONENTS

INFEED ELEMENTS



Black (Standard)



Sandblasted

ALUMINUM (STANDARD)

- 2 standard widths: 41 mm & 52 mm
- Standard is black powder-coated
- Powder-coated in other colors upon request
- Sandblasted and not powder-coated (cost-effective alternative)
- Robust construction Identical to plastic infeed element

* Custom colors available upon request



PLASTIC

- 2 standard widths: 41 mm & 52 mm
- Flexibility available as well
- BLOKSMA standard: black, yellow, orange, red, ultramarine, turquoise green
- Plastic can be replaced by aluminum at any time



Custom colors available upon request



CUSTOM DESIGNS



STEEL

- Very robust construction
- Steel surface galvanized
- 2 standard widths: 41 mm & 52 mm
- Other widths available upon request
- Flexibility available as well
- Available in stainless steel upon request



INDIVIDUAL COMPONENTS

LABELING



More colors
available upon
request



CLOSING CLIP



This secures the transparent film
and the contents are secured.



Placard frames in various sizes available.

MOUNTING OPTIONS

H = HANGING



Advantage:

Placard frames can be easily and quickly replaced.

Due to their flexible mounting, they are less prone to breakage.

B = STANDING



Advantage:

Placard frames can be easily and quickly replaced.

P = STANDING

fixed or rotatable



Advantage:

Placard frames are firmly anchored.

They can also be mounted to rotate.



INDIVIDUAL COMPONENTS

BRAKE SYSTEMS

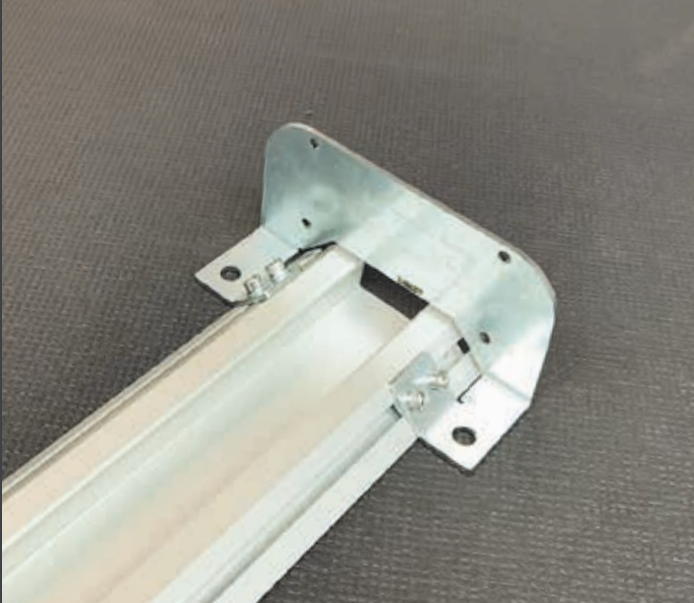

END STOP

When the supermarket is used unidirectionally, i.e., not passable, the end stop is used. Either the wheel or the trolley frame is stopped with it. The stop can be easily, quickly, and continuously attached to the guide rail.



NON-RETURN

The simplest way to stop a wheel from rolling. The wheel is prevented from rolling away by 2 „wedges“. There are 2 heights: 6 mm or 10 mm. These can also be combined. The back-flow preventers are simply glued into the guide rail.

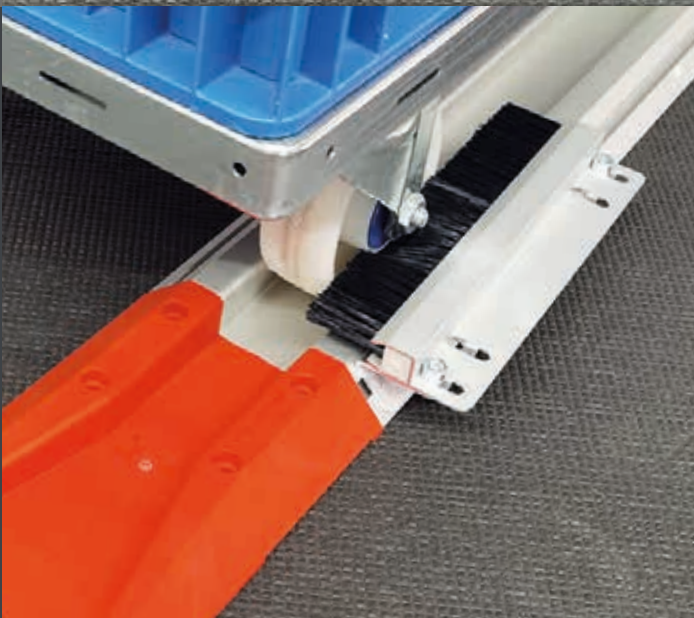

BRUSH BRAKE

The brush brake slows down the wheel gradually through friction. By adjusting the brush, the braking effect can be adjusted.

MECHANICAL STOPPER

This stopper is purely mechanical. It functions like a gas pedal.

There are 2 types of stoppers:

1. Inlet area: the floor roller cannot roll back.
2. Outlet area: the floor roller cannot be pushed through.

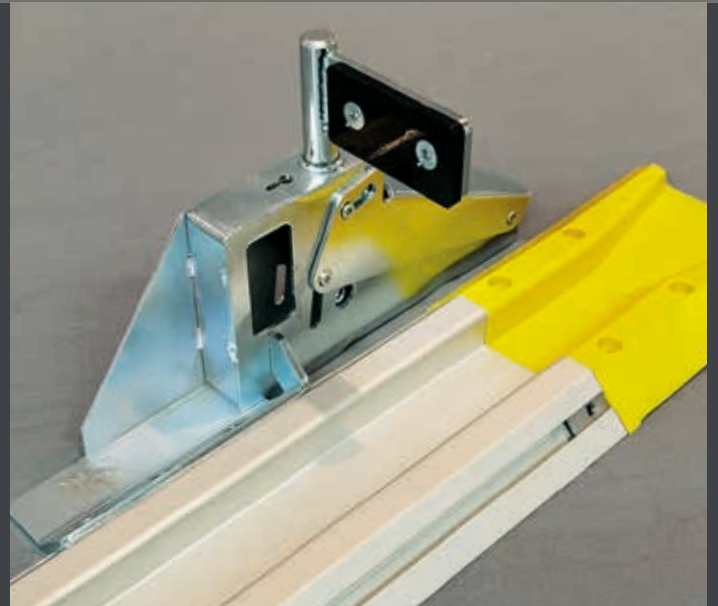

ELECTRIC STOPPER

Similar to the mechanical stopper, this one is triggered by an impulse. However, in this case, it is triggered electronically by a button or similar device.

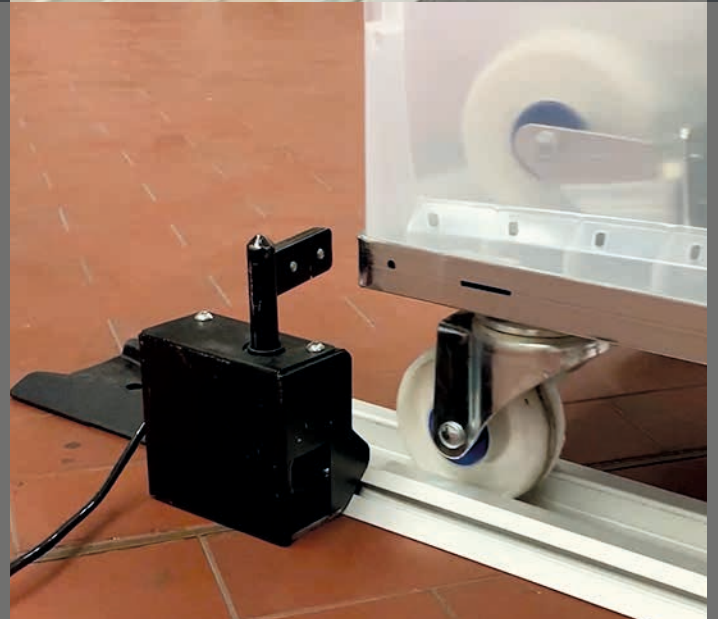

PARKING LOT

A parking lot secures a trolley against unintended rolling away, reducing the risk of accidents. Additionally, it defines the parking space for the trolley and spares the brake on the trolley.



ACCESSORIES

TOP-STRUCTURE WITH CONVEYOR BELT ON SHELF

Above the floor rails of the supermarket, we can install pass-through rails with rollers as needed. These can transport KLTs (small load carriers) according to the FIFO principle and the Karakuri function (low-cost automation) from back to front.



LEVEL INDICATOR / E-KANBAN

With our partners, we can install measuring devices on the supermarket. These detect whether the supply is guaranteed or whether new goods need to be ordered. Orders can thus be automatically triggered.



FTS (FAHRERLOSE TRANSPORTSYSTEME) / AMR (AUTOMATED MOBILE ROBOTS)



The FTS (Driverless Transport System) can automatically load and unload the supermarket. In times of skilled labor shortages and automation, this is a good alternative to keep your smart factory running.

AUTOMATED REFILL DEVICE FIFO reimagined intelligently

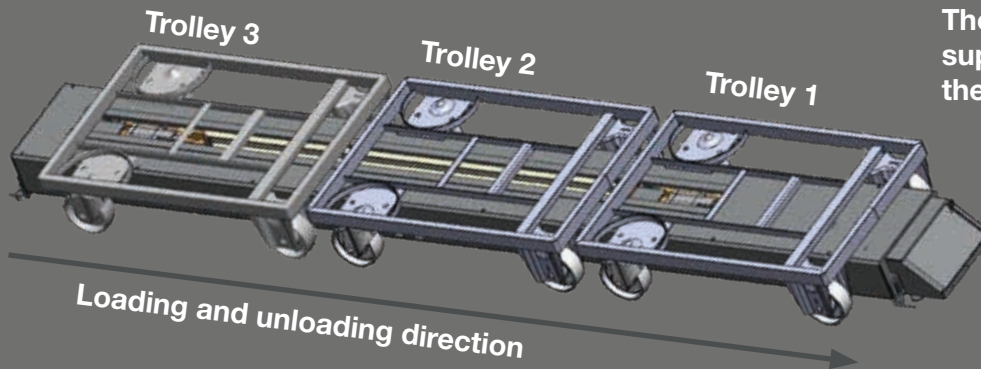

The length of the automatic refill supermarket is custom-made to fit the customer's needs.

Long and narrow supermarket lanes pose a challenge for employees as they may find it difficult to retrieve the trolleys at the rear. Thanks to BLOKSMA's automated refill device, this problem can be solved. With this unit, the rear-most trolley is brought forward, making it readily available at the end of the lane for retrieval. The sensors of the automatic refill supermarket detect the positions of the trolleys. If the front sensor is unoccupied, a trolley is automatically pushed forward from the rear. This way, the supermarket branches out the trolleys from back to front after each retrieval. Currently, BLOKSMA is conducting studies aimed at better automating the internal material flow in the supermarket. You can look forward to seeing the solutions BLOKSMA will offer in the near future.

NEW: DOLLY MOVER

BLOKSMA is currently working on a groundbreaking new study that will revolutionize the FIFO principle in the supermarket. Imagine a system that can be implemented cost-effectively in the supermarket and automatically brings trolleys from the back to the front at high speed. Employees no longer need to navigate through the trolleys to reach the ones at the back. Time is also saved as the FTS no longer needs to slowly maneuver into the supermarket to reach the back corner. The Dolly Mover brings the trolleys directly to the exit, from where an FTS can conveniently pick them up. This also simplifies the loading of the supermarket.

APPLICATIONS



RENOWNED COMPANIES TRUST BLOKSMA SOLUTIONS:

AEG • Allweiler • AMG • Arburg • Atlas Copco • Audi • Behr • Benzinger • Beru
Bitzer • BMW • Boge • BorgWarner • Bosch • Brose • BRP-Rotax • BSH • Bürkert
Caterpillar • Continental • Daimler Truck • Danfoss • Eaton • Eberspächer
ebm-papst • EMAG • FAG • Faurecia • Federal-Mogul • Fein • Felsomat • Festo • Ford
Gardena • Gemü • Georg Fischer • Getrag • GKN • Grob • Güdel • Hanning • HandlingTech

APPLICATIONS

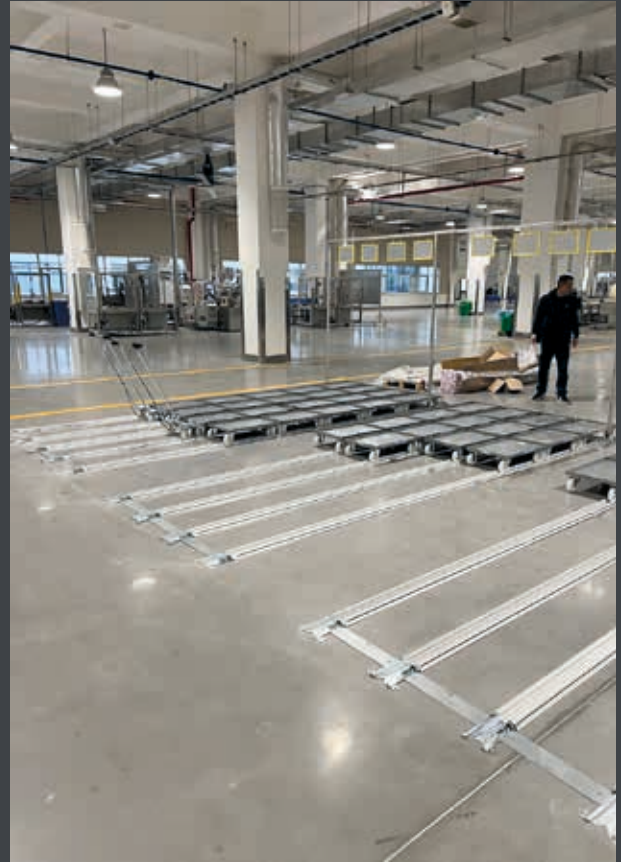

Hansgrohe • Hatz • Heidelberg • Hella • Hoerbiger • Husky • IFA • IMS Gear
John Deere • Knipex • Kärcher • KUKA • Liebherr • LUK • Lütze • Magna Steyr
Mahle • MAN • Mannesmann • Mercedes Benz • Metabo • Miele • Nidec • Opel
Parker • Pierburg • Porsche • Promot • Schaeffler • SEW • Siemens • Stihl
Thyssenkrupp • Trelleborg • Valeo • Vibracoustic • Volkswagen • Vorwerk • Wabco • Wago • ZF

EVERYTHING FROM ONE SOURCE



1 | TROLLEY



2 | LIFTER

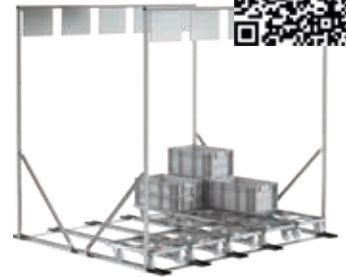

3/4 | SUPERMARKET
AND PARKING LOT



5 | TRANSPORT
LOGISTIC



6 | FLOW RACK



7 | WORKPIECE
CARRIER



www.bloksma.de



BLOKSMA-Engineering GmbH
Materialflusstechnik

Daimlerstraße 10
DE - 73660 Urbach b. Stuttgart

T: +49 7181 98 556-0
F: +49 7181 98 556-42

mail@bloksma.de
www.bloksma.de

